

SERVICE MANUAL

COMPUTERIZED
FULLY AUTOMATIC DD TURNTABLE

SANSUI P-L75 (Silver & Black Model)



CAUTION

1. Parts identified by the Δ symbol on the schematic diagram and the parts list are critical for safety. Use only replacement parts that have critical characteristics recommended by the manufacturer.
2. Make leakage-current or resistance measurements to determine that exposed parts are acceptably insulated from the supply circuit before returning the appliance to the customer.

Sansui

SANSUI ELECTRIC CO., LTD.

P-L75

P-L75

● SPECIFICATIONS

Type	Direct-drive turntable
Rated speeds	33-1/3, 45 rpm
Platter	Aluminum alloy diecast, 306 mm (12-1/16") diameter, 0.75 kg (1.7 lbs.) weight
Motor	Coreless and Brushless DC/FG Servo
Wow/flutter	0.035% (WRMS)
Signal-to-noise ratio	Better than 72 dB (DIN-B) Better than 60 dB (IEC-B)
Effective tonearm length	140 mm (5-1/2")
Cartridge	Dual Magnet type (SV-S707)
Output voltage	2.5 mV (1,000 Hz, 35.4 mm/sec)
Correct load impedance	47 kohms
Frequency response	10 ~ 20,000 Hz
Stylus	0.6 mil diamond stylus (SN-707 replacement stylus)
Others	
Power voltage	110 ~ 120/220 ~ 240V (50/60 Hz)
For U.S.A. and Canada	120V (60 Hz)
Power consumption	25 W
Dimensions	430 mm (16-29/32") W 95 mm (3-3/4") H 374 mm (14-23/32") D
Weight	5.6 kg (12.4 lbs.) net 6.7 kg (14.7 lbs.) packed

- Design and specifications subject to change without notice for improvements.
- Due to local laws and regulations, this unit sold in some areas are not equipped with variable voltage selectors.

CAUTION

1. The symbols, UL, CSA, SA, BS, UK, EU, AS and XX on the parts list and the schematic diagram mean followings respectively.
UL Manufactured for U.S.A market.
(Underwriters Laboratories approved model.)
CSA Manufactured for Canadian market.
SA Manufactured for South African market.
BS, UK Manufactured for United Kingdom market.
EU Manufactured for European market.
AS Manufactured for Australian market.
XX Standard Version.
NON MARK Common Parts.
2. Some printed circuit boards are not supplied as the assembled. To separate these in this service manual, the stock No's are not indicated at the ends of the board names. However, the individual parts on the circuit boards are provided by orders.
3. Since some of capacitors and resistors are omitted from parts lists in this service manual, refer to the Common Parts List for capacitors & resistors, which was issued on February 1983.
4. Abbreviations in this service manual are as follows.

• Abbreviations List

C.R. : Carbon Resistor	E.B.L. : Low Leak Bi-Polar Electrolytic Capacitor
S.R. : Solid Resistor	Ta.C. : Tantalum Capacitor
Ce.R. : Cement Resistor	F.C. : Film Capacitor
M.R. : Metal Film Resistor	M.P. : Metalized Paper Capacitor
F.R. : Fusing Resistor	P.C. : Polystyrene Capacitor
N.I.R. : Non-Inflammable Resistor	G.C. : Gimmic Capacitor
A.R. : Array Resistor	A.C. : Array Capacitor
C.C. : Ceramic Capacitor	V.R. : Variable Resistor
C.T. : Ceramic Capacitor, Temperature Compensation	S.V.R. : Semi Variable Resistor
E.C. : Electrolytic Capacitor	SW. : Switch
E.L. : Low Leak Electrolytic Capacitor	Chip R. : Chip Resistor
E.B. : Bi-Polar Electrolytic Capacitor	Chip C. : Chip Capacitor

1. BLOCK DIAGRAM

1-1. Logic Control Section

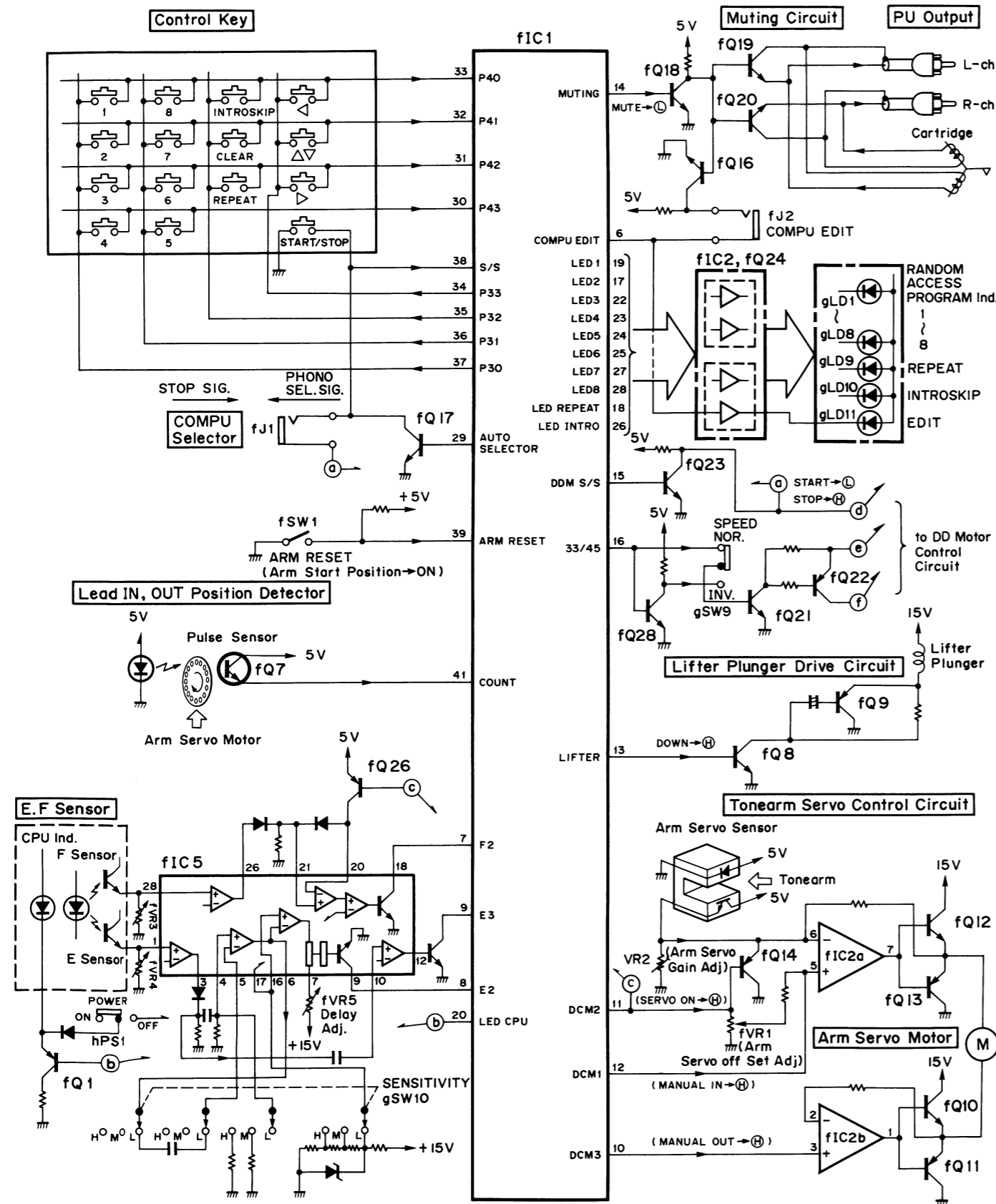

1-2. DD Motor Control Section

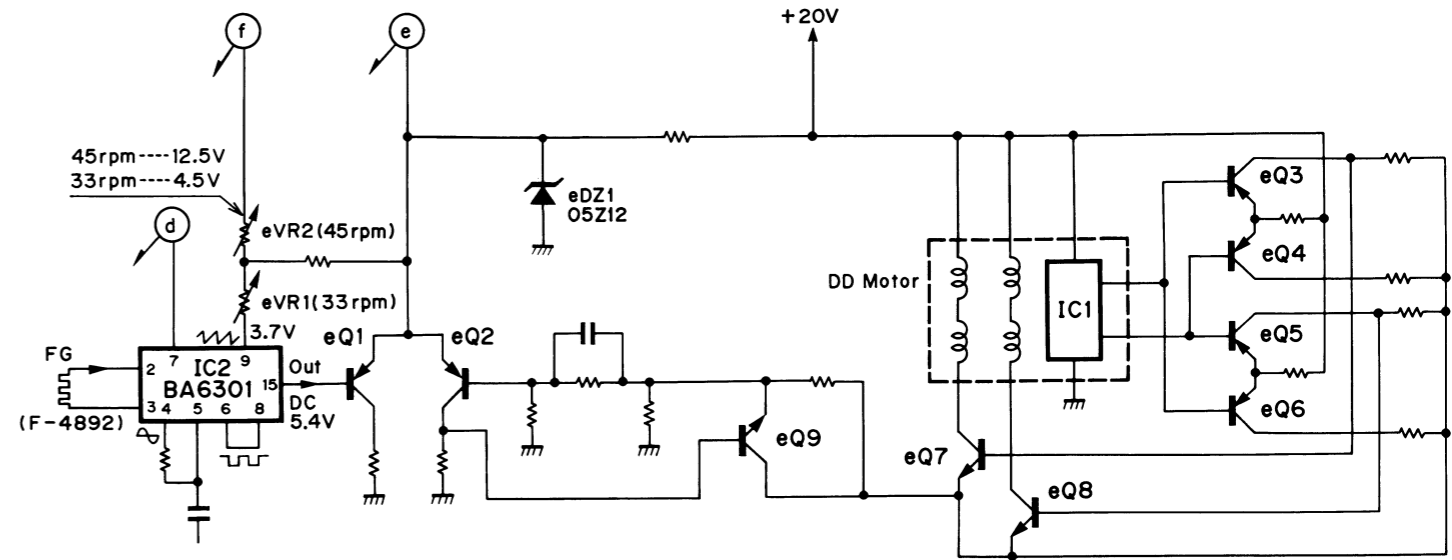

Pattern drawing of motor section (F-4892 Motor Control Circuit Board)

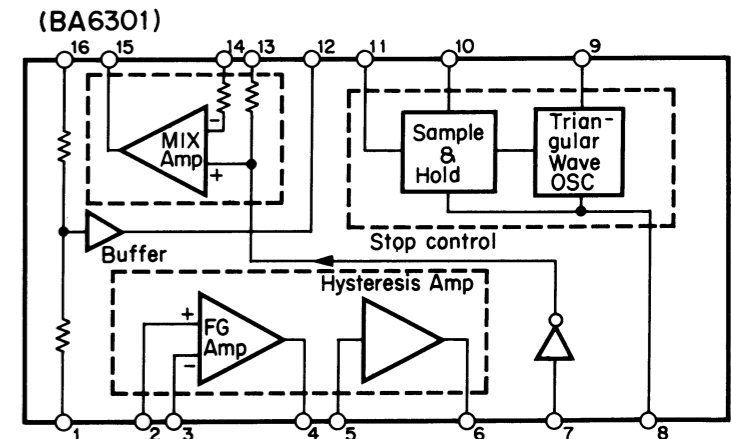
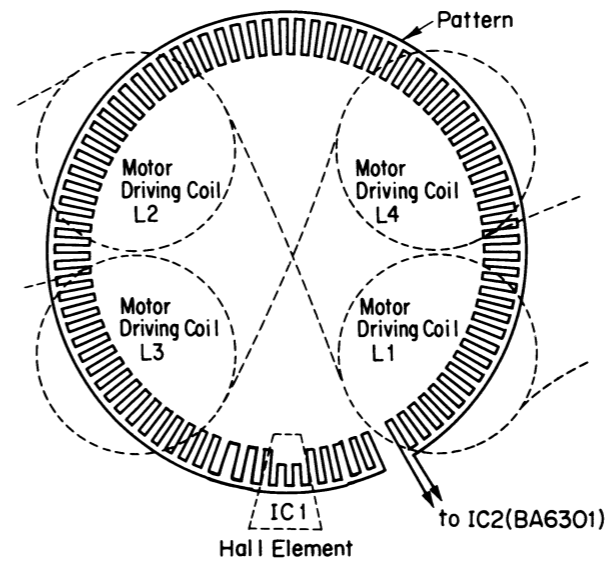

2. TIMING CHART OF MICROCOMPUTER μ PD7528C-019

2-1. Automatic Music Selection Program 2-3-5 (Introskip) <30cm, 33rpm>

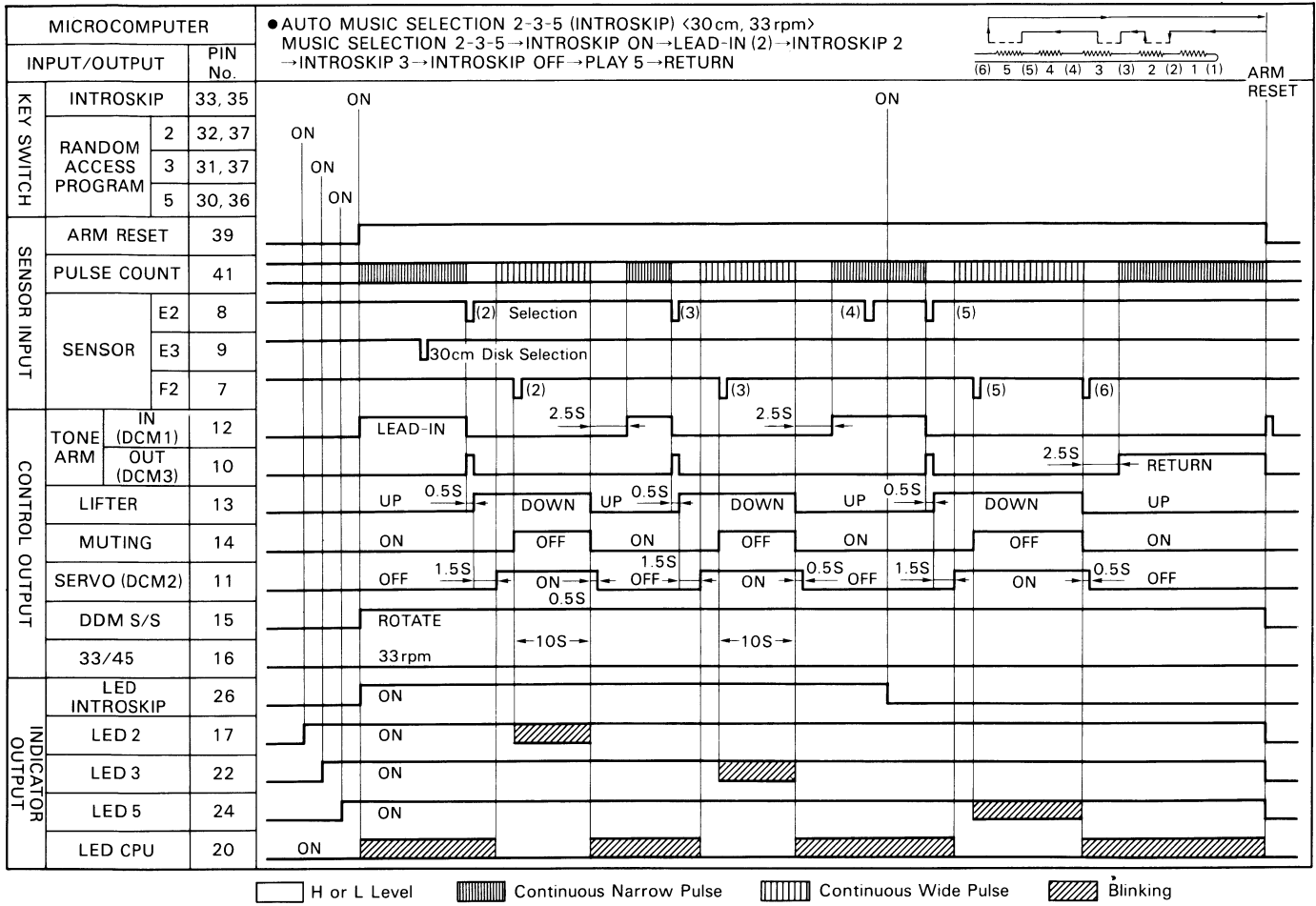

2-2. Automatic Disk size Detection <17cm, 45rpm>

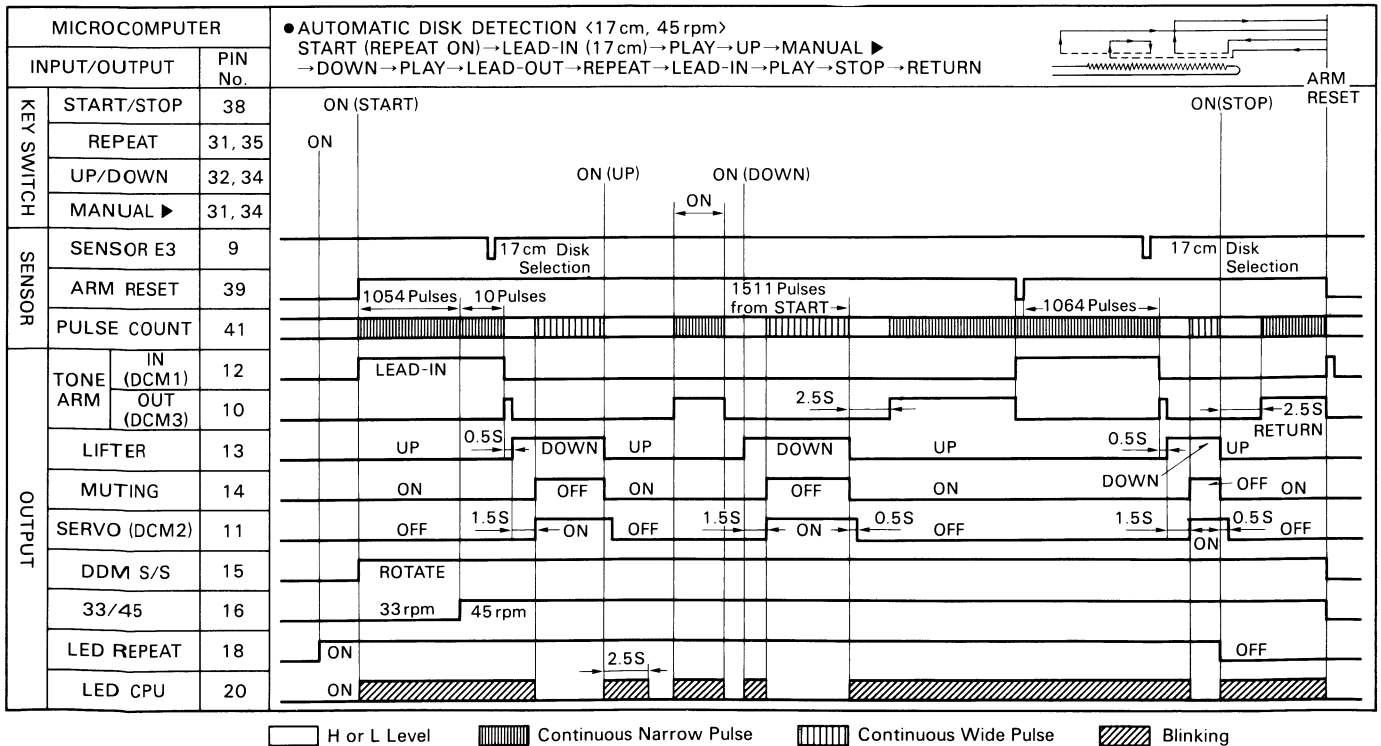

3. ADJUSTMENT

3-1. Lead-in operation adjustment

- 1) Perform the lead-in operation with a 30cm record disk having a narrow lead-in groove, and adjust the lead-in adjusting cam (See Fig. 3-2) so that the stylus tip comes down to the center of the lead-in groove.
- 2) Perform the lead-out operation and check that the stylus tip is lifted up at the lead-out groove.
- 3) Perform the lead-in operation with a 17cm record disk having a narrow lead-in groove, and check that the stylus tip comes down to the lead-in groove.

Fig.3-1

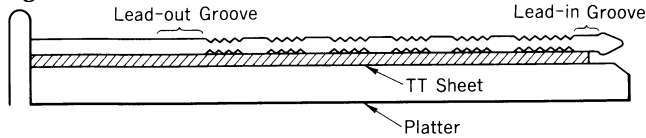

3-2. Speed adjustment (Refer to Fig. 3-2.)

- 1) Set the speed to 33 rpm and adjust the eVR1 on the F-4892 DD motor control board using a small screwdriver so that the 33 rpm strobo pattern is seen to stop.
- 2) Set the speed to 45 rpm and adjust the eVR2 on the F-4892 DD motor control board using a small screwdriver so that the 45 rpm strobo pattern is seen to stop.

3-3. Arm servo adjustment

* Before adjustment, remove the TT sheet, the platter and the cabinet.

- 1) Connect a DC voltmeter between T.P. SERVO and GND. (See Fig. 3-4)
- 2) Move the tonearm by manual operation so that the stylus tip is positioned at approx. 110mm away from the center of the DD motor.
- 3) Move the cartridge portion of the tonearm rightward by hand until it will stop, and adjust fVR2 (Fig. 3-4) so that the reading of the DC voltmeter is $4.0 \pm 0.2V$.
- 4) Turn fVR1 (Fig. 2-5) fully counterclockwise.
- 5) Place a spacer (approx. 4mm in height as Fig. 3-3) under the arm lifter.
- 6) Press the START/STOP key to rotate the DD motor.
- 7) Press the UP/DOWN key to lower the tonearm, and turn fVR1 gradually clockwise and stop turning when the tonearm starts moving leftward.
- 8) Actually play a music positioned approx. 110mm away from the center of the 30cm record disk. Press the UP/DOWN key several times, and check that the stylus tip moves up and down vertically. If the stylus tip moves slightly rightward (or leftward), turn fVR1 a little clockwise (or counterclockwise).

Fig.3-2 Bottom View

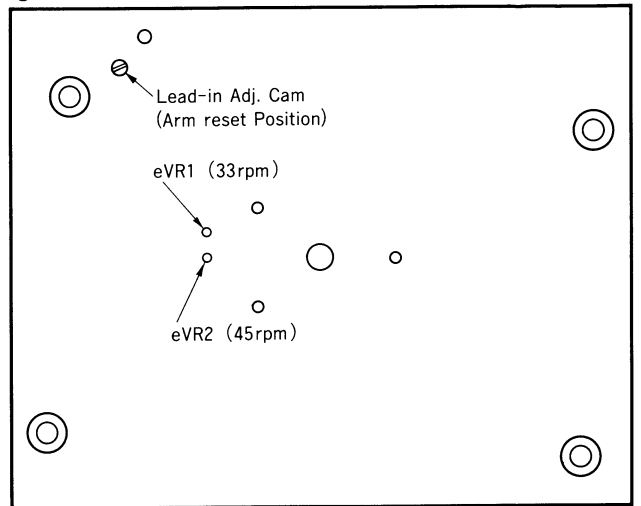

Fig.3-3

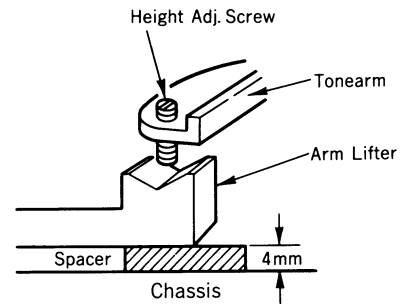
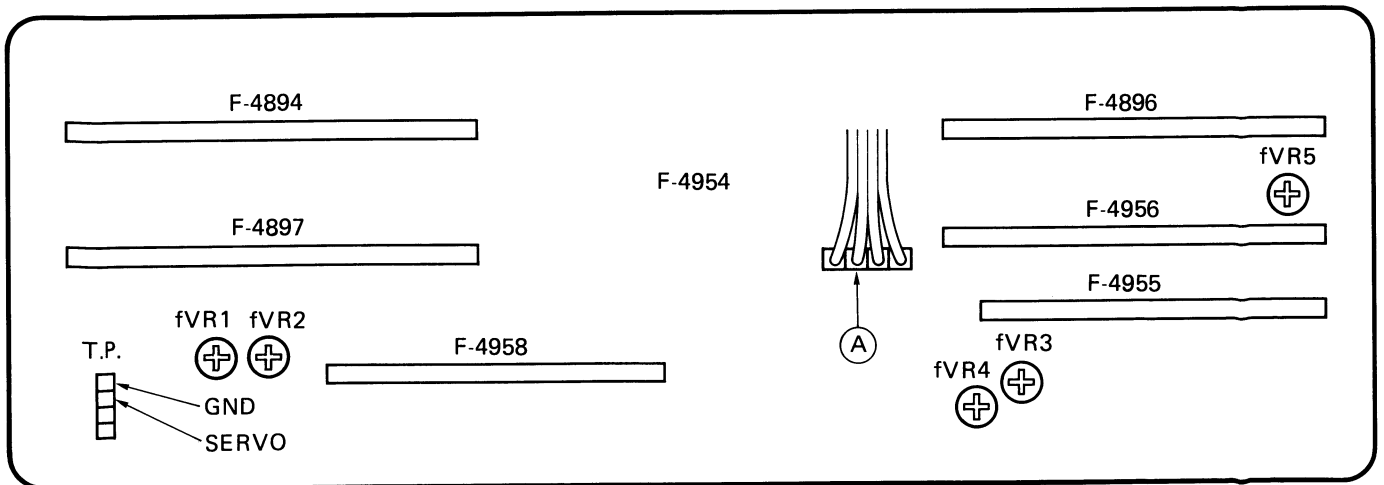

Fig.3-4 F-4954 Test & Adjustment points



3-4. Automatic music selection adjustment (Refer to Fig. 3-3, 3-4 and 3-5.)

* For this adjustment, a vinyl chloride record disk without groove or with wider lead-out spiral than usual is required.

A. Tonearm height adjustment (Refer to Fig. 3-5.)

* Before adjustment, remove the player case cover.

- 1) Move the tonearm by manual operation so that the stylus tip is positioned at approx. 110mm away from the center of the platter.
- 2) Adjust the tonearm height adjusting screw (See Fig. 3-3) so that the clearance between the record disk and the stylus tip is within 6.5 ~ 7.0mm.

B. Sensitivity adjustment of E and F sensor

* Before adjustment, remove the cabinet.

- 1) Move the tonearm by manual operation and stop the stylus tip at approx. 110mm away from the disk center.
In case of a record disk has a groove, stop the stylus tip above the flat surface nears 110mm away from the disk center.
- 2) Connect the DC voltmeter across the pin No. 3 of f1C5 (F-4955) and ground, and adjust fVR4(Fig. 3-4) so that the reading of the DC voltmeter is 2.5V.
- 3) Press the UP/DOWN key to lower the stylus tip.
- 4) Connect the DC voltmeter across the pin No. 26 of f1C5 and the ground, and adjust fVR3(Fig. 3-4) so that the reading of the DC voltmeter is 2.5V.

3-5. Delay adjustment of E2 signal

* Use the record disk with narrower music intervals.

- 1) Connect the DC voltmeter across the point (A) (Fig. 3-4) and the ground.
- 2) Play a music positioned after narrower music interval by automatic music selection, and check that the stylus tip comes down on or a little before the music interval for the selected music.
- 3) Adjust fVR5(Fig. 3-4) so that +5V is applied to the point (A) within 10 second after the stylus tip moves down.
The desirable time is from 4 to 6 second.

3-6. Lateral-direction adjustment of E and F sensor

* This adjustment is required only when the automatic music selection operation is insufficient even after the adjustments 3-4 and 3-5 are performed.

- 1) Mount a 30cm record disk having many music groove.
- 2) Set the SENSITIVITY switch to H when the music interval is narrow, and to M when medium.
- 3) Connect the DC voltmeter across the point (A) and ground.
- 4) Press the music selection key for the 2nd music, and also the START/STOP key.
- 5) After the CPU indicator stops blinking, press the UP/DOWN key to lift up the arm.
- 6) Turn the pulley(A) of the arm servo mechanism(See Top View on page 13.) so that the stylus tip moves above a position 2mm or more outward from the music interval between 1st and 2nd music. (See Fig. 3-6)
- 7) Press the UP/DOWN key to play the end portion of the 1st music.
- 8) Adjust the positions of E and F sensor by turning the adjusting screw(Fig. 3-7) so that the voltage of the point (A) turns off immediately after the 1st music sound is ended.

Fig.3-5 (a)

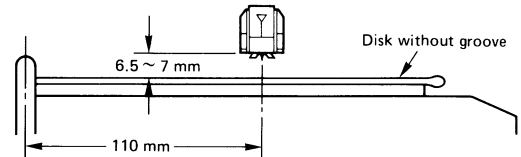

Fig.3-5 (b)

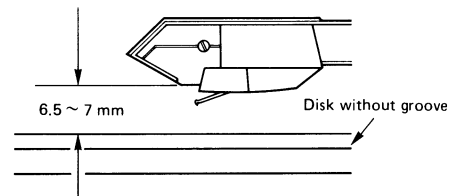

Fig.3-6

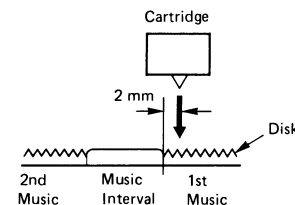
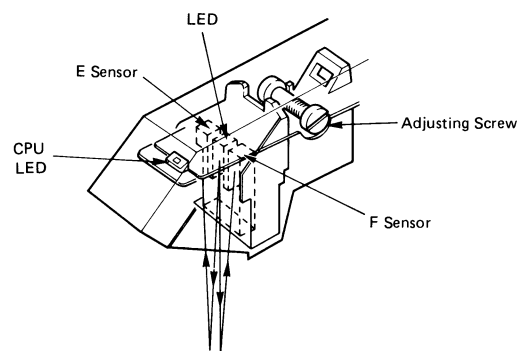

Fig.3-7



4. PARTS LOCATION & PARTS LIST

4-1. F-4892 DD Motor Control Board

Component Side

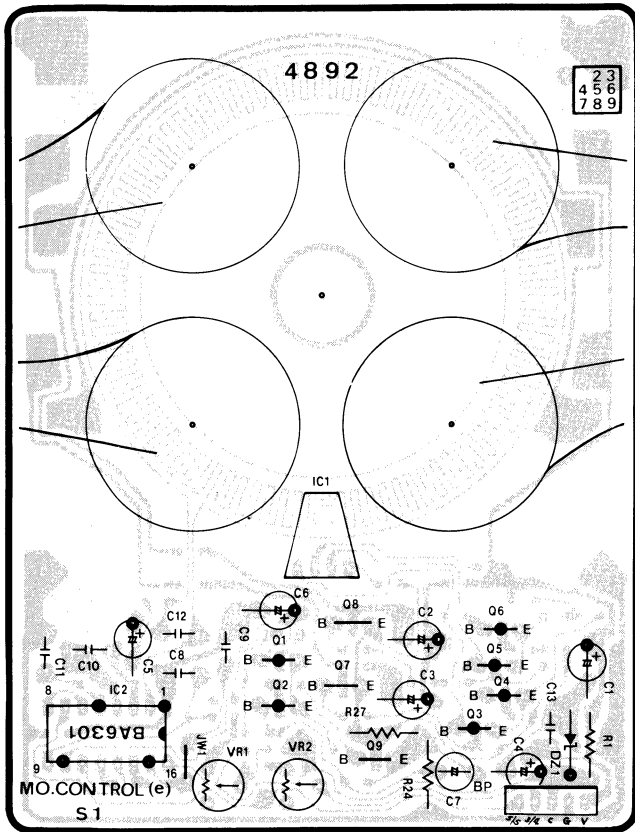

Parts List

Parts No.	Stock No.	Description
• Transistor		
eQ1	46367001	2SA1115
	or 46367201	2SA1048
	or 46392001	2SA1175
	or 48058601	2SA933S
eQ2	46367001	2SA1115
	or 46367201	2SA1048
	or 46392001	2SA1175
	or 48058601	2SA933S
eQ3	46367001	2SA1115
	or 46367201	2SA1048
	or 46392001	2SA1175
	or 48058601	2SA933S
eQ4	46367001	2SA1115
	or 46367201	2SA1048
	or 46392001	2SA1175
	or 48058601	2SA933S
eQ5	46367001	2SA1115
	or 46367201	2SA1048
	or 46392001	2SA1175
	or 48058601	2SA933S
eQ6	46367001	2SA1115
	or 46367201	2SA1048
	or 46392001	2SA1175
	or 48058601	2SA933S
eQ7	46359801	2SC2001
	or 46614101	2SC3243
	or 48000901	2SC2060
eQ8	46359801	2SC2001
	or 46614101	2SC3243
	or 48000901	2SC2060
eQ9	03083901	2SD313AL
	or 46546701	2SD880

Pattern Side (Chip Parts)

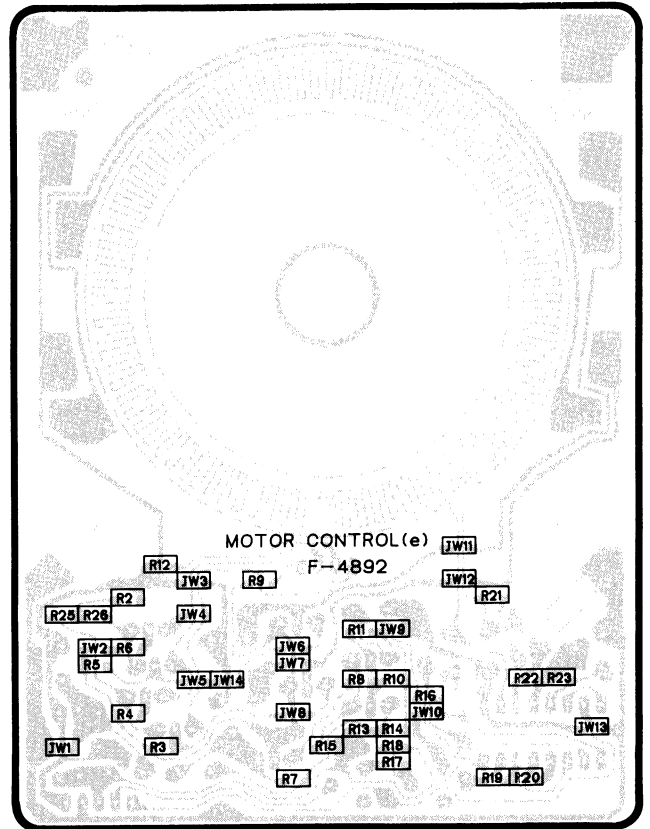

Parts No.	Stock No.	Description
• IC		
eIC1	46354301	HW-301C-Q
	or 46354302	HW-301C-R
eIC2	46354400	BA6301
• Diode		
eD1	46612000	1S2473D-VL
• Zener Diode		
eDZ1	46103700	05Z12-Y
eJW1 ~ 13	46741100	Cross Conductor (Chp)
Δ eR1	46229900	560 Ω 1/2W N.I.R.
eR2	46747400	820 Ω 1/8W Chip R.
eR3	46749200	4.7 KΩ 1/8W Chip R.
eR4	46749200	4.7 KΩ 1/8W Chip R.
eR5	46749200	4.7 KΩ 1/8W Chip R.
eR6	46749200	4.7 KΩ 1/8W Chip R.
eR7	46750000	10 KΩ 1/8W Chip R.
eR8	46747600	1 KΩ 1/8W Chip R.
eR9	46747600	1 KΩ 1/8W Chip R.
eR10	46747600	1 KΩ 1/8W Chip R.
eR11	46747600	1 KΩ 1/8W Chip R.
eR12	46747300	750 Ω 1/8W Chip R.
eR15	46746600	390 Ω 1/8W Chip R.
eR16	46752600	120 KΩ 1/8W Chip R.
eR17	46753400	270 KΩ 1/8W Chip R.
eR18	46753300	240 KΩ 1/8W Chip R.
eR19	46750300	13 KΩ 1/8W Chip R.
eR20	46747900	1.3 KΩ 1/8W Chip R.
eR21	46745200	100 Ω 1/8W Chip R.
eR22	46753600	330 KΩ 1/8W Chip R.
eR23	46751600	47 KΩ 1/8W Chip R.

Parts List <F-4892>

Parts No.	Stock No.	Description
△ eR24	46227000	2.2 Ω 1/2W N.I.R.
eR25	46745200	100 Ω 1/8W Chip R.
eR26	46745200	100 Ω 1/8W Chip R.
△ eR27	46230000	680 Ω 1/2W N.I.R.
eC1	46929700	33 μF 25V E.C.
eC2	46929600	22 μF 25V E.C.
eC3	46929600	22 μF 25V E.C.
eC4	46928700	22 μF 16V E.C.

Parts No.	Stock No.	Description
eC5	46929200	4.7 μF 25V E.C.
eC6	46930800	0.22 μF 50V E.C.
eC7	48165000	0.1 μF 50V E.B.
eC8	46284100	0.1 μF 50V F.C.
eC9	46282900	0.01 μF 50V F.C.
eVR1	46634900	100 KΩ S.V.R., 33rpm Adj.
eVR2	46635300	470 KΩ S.V.R., 45rpm Adj.

4-2. F-4894 Power Supply Board (Stock No. 00875501)

Component Side

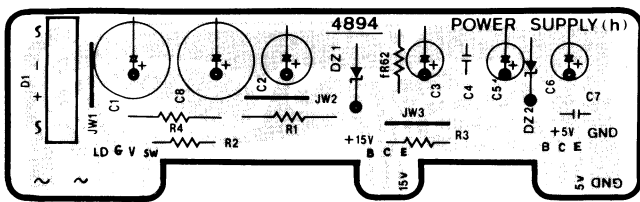

Parts List

Parts No.	Stock No.	Description
• Diode		
△ hD1	03117000	RB152-LFF
• Zener Diode		
hDZ1	46114600	05Z15-Z
	or 46114700	05Z16-X
hDZ2	46111400	05Z5.6-X
	or 46111500	05Z5.6-Y
△ hR1	46624900	330 Ω 2W N.I.R.
△ hR2	46229000	100 Ω 1/2W N.I.R.
△ hR3	46230600	2.2 KΩ 1/2W N.I.R.
△ hR4	00116200	4.7 Ω 1/2W F.R.

4-3. F-4896 Lifter Plunger & Muting Driver Board (Stock No. 00875601)

Component Side

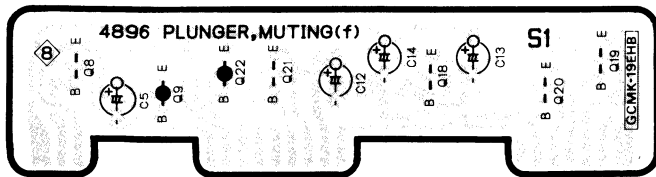

Parts List

Parts No.	Stock No.	Description
• Transistor		
fQ8	46367101	2SC2603
fQ9	46359701	2SA952
	or 46614001	2SA1283
	or 48000801	2SA934
fQ18	46367101	2SC2603
	or 46367301	2SC2458
	or 48058801	2SC1740S
fQ19	46540801	2SC2878
	or 46604301	2SC3327
	or 48055901	2SD1468S
fQ20	46540801	2SC2878
	or 46604301	2SC3327
	or 48055901	2SD1468S
fQ21	48171600	DTC114YS
fQ22	48183400	DTA114YS

Pattern Side (Chip Parts)

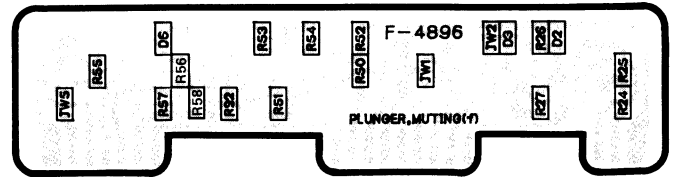

Parts No.	Stock No.	Description
• Diode		
fd2	46852000	RLS-73 (Chip)
fd3	46852000	RLS-73 (Chip)
fd6	46852000	RLS-73 (Chip)
fJW1,3,5	46741100	Cross Conductor (Chip)
fr24	46749200	4.7 KΩ 1/8W Chip R.
fr25	46748800	3.3 KΩ 1/8W Chip R.
fr26	46751600	47 KΩ 1/8W Chip R.
fr27	46745200	100 Ω 1/8W Chip R.
△ fr28	46249600	180 Ω 1W N.I.R.
fr50	46750000	10 KΩ 1/8W Chip R.
fr51	46748400	2.2 KΩ 1/8W Chip R.
fr52	46752400	100 KΩ 1/8W Chip R.
fr53	46749200	4.7 KΩ 1/8W Chip R.
fr54	46750000	10 KΩ 1/8W Chip R.
fr55	46749600	6.8 KΩ 1/8W Chip R.
fr56	46749600	6.8 KΩ 1/8W Chip R.
fr92	46752400	100 KΩ 1/8W Chip R.

4-4. F-4897 Tonearm Servo Board (Stock No. 00875701)

Component Side

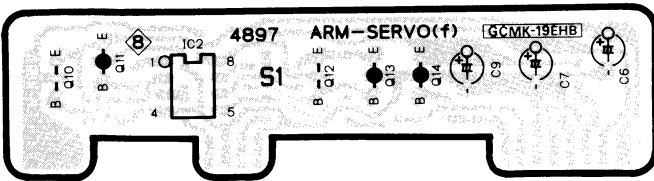

Pattern Side (Chip Parts)

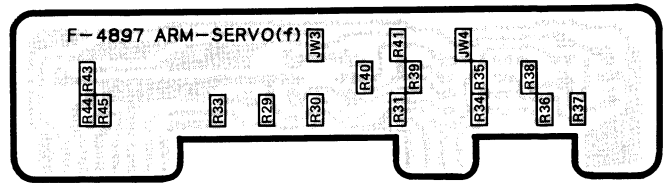

Parts List

Parts No.	Stock No.	Description
• Transistor		
fQ10	46359801	2SC2001
	or 46614101	2SC3243
	or 48000901	2SC2060
fQ11	46359701	2SA952
	or 46614001	2SA1283
	or 48000801	2SA934
fQ12	46359801	2SC2001
	or 46614101	2SC3243
	or 48000901	2SC2060
fQ13	46359701	2SA952
	or 46614001	2SA1283
	or 48000801	2SA934
fQ14	46367001	2SA1115
	or 46367201	2SA1048
	or 48058601	2SA933S
• IC		
fIC2	46173100	NJM2904D
	or 48163600	BA728

Parts No.	Stock No.	Description
fJW3,4	46741100	Cross Conductor (Chip)
fR29	46750000	10 K Ω 1/8W Chip R.
fR30	46751400	39 K Ω 1/8W Chip R.
fR31	46750000	10 K Ω 1/8W Chip R.
fR33	46750000	10 K Ω 1/8W Chip R.
fR34	46751400	39 K Ω 1/8W Chip R.
fR35	46750000	10 K Ω 1/8W Chip R.
fR36	46750000	10 K Ω 1/8W Chip R.
fR37	46753200	220 K Ω 1/8W Chip R.
fR38	46745200	100 Ω 1/8W Chip R.
fR39	46745200	100 Ω 1/8W Chip R.
fR40	46753200	220 K Ω 1/8W Chip R.
fR41	46749400	5.6 K Ω 1/8W Chip R.
fR43	46750400	15 K Ω 1/8W Chip R.
fR44	46747600	1 K Ω 1/8W Chip R.
fR45	46746200	270 Ω 1/8W Chip R.
Δ fR90	00112800	4.7 Ω 1/4W F.R.

4-5. F-4903 Pulse Counter & Arm Servo Sensor Board

Component Side

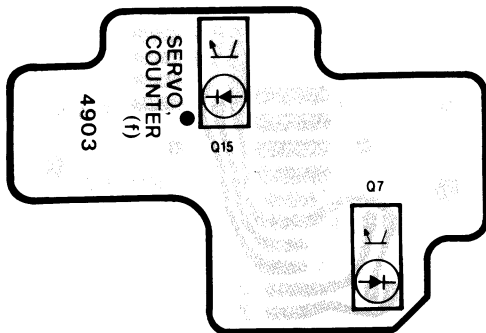

Parts List

Parts No.	Stock No.	Description
fQ7	46395800	Photo Interrupter GP-1S04
fQ15	46938400	Photo Interrupter ON1128

4-6. F-4926 Power Switch Board

Component Side

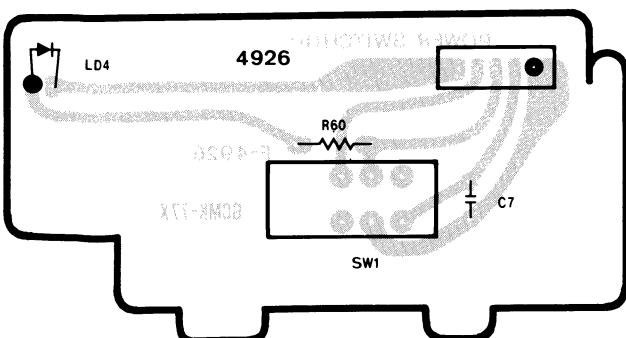

Parts List

Parts No.	Stock No.	Description
• LED		
gLD4	46095200	TLR123, STAND-BY
Δ hSW1	48175900	Push SW., POWER

4-7. F-4954 Microcomputer & Operation Key Board (Stock No. 00875801)

Component Side

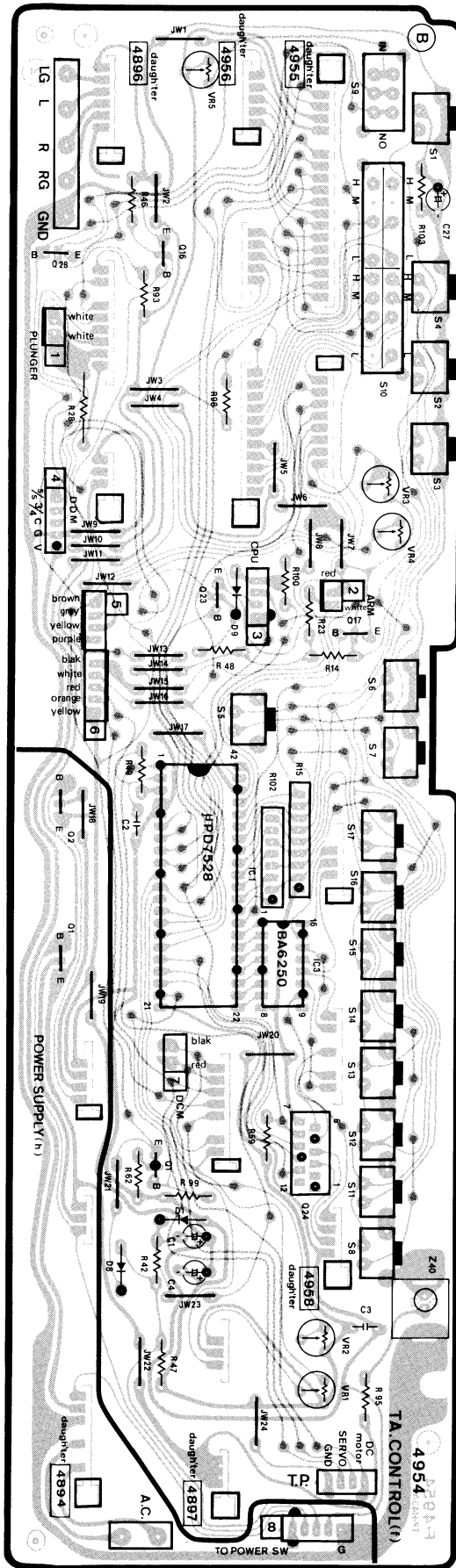

Parts List

Parts No.	Stock No.	Description
• Transistor		
fQ1	46367001	2SA1115
	or 46367201	2SA1048
	or 48058601	2SA933S
fQ16	46367101	2SC2603
	or 46367301	2SC2458
	or 48058801	2SC1740S
fQ17	48171600	DTC114YS
fQ23	48171600	DTC114YS
fQ24	46933800	DT5C114E
fQ25	48171600	DTC114YS
fQ28	48171600	DTC114YS
• IC		
fic1	48158500	μPD7528C-019
fic3	48183300	BA6250
• Diode		
fd1	03117600	1S2473T77
fd8	03117600	1S2473T77
fd9	03117600	1S2473T77
fr12	46748800	3.3 KΩ 1/8W Chip R.
fr13	46750000	10 KΩ 1/8W Chip R.
fr15	46349300	10 KΩ x 8 A.R.
fr95	46228300	27 Ω 1/2W N.I.R.
fr102	48076000	100 KΩ x 4 A.R.
fvr1	46634100	4.7 KΩ S.V.R., Offset Adj.
fvr2	46634500	22 KΩ S.V.R., Servo Gain Adj.
fvr3	46635100	220 KΩ S.V.R., F Sensor Adj.
fvr4	46635100	220 KΩ S.V.R., E Sensor Adj.
fvr5	46635300	470 KΩ S.V.R., Delay Adj.
gpl1	48180000	14 V 0.1A Pilot Lamp
gsw1	46395900	Push SW., START/STOP
gsw2	46395900	Push SW., MANUAL ◀
gsw3	46395900	Push SW., MANUAL ▶
gsw4	46395900	Push SW., UP/DOWN
gsw5	46395900	Push SW., INTROSKIP
gsw6	46395900	Push SW., REPEAT
gsw7	46395900	Push SW., CLEAR
gsw8	46395900	Push SW., 1
gsw9	46133600	Slide SW., SPEED
gsw10	46133500	Slide SW., SENSITIVITY
gsw11	46395900	Push SW., 2
gsw12	46395900	Push SW., 3
gsw13	46395900	Push SW., 4
gsw14	46395900	Push SW., 5
gsw15	46395900	Push SW., 6
gsw16	46395900	Push SW., 7
gsw17	46395900	Push SW., 8
• Transistor		
hQ1	03083901	2SD313AL
	or 46546701	2SD880
hQ2	03083901	2SD313AL
	or 46546701	2SD880

4-8. F-4955 Random Access Control Board (Stock No. 00875901)

Component Side

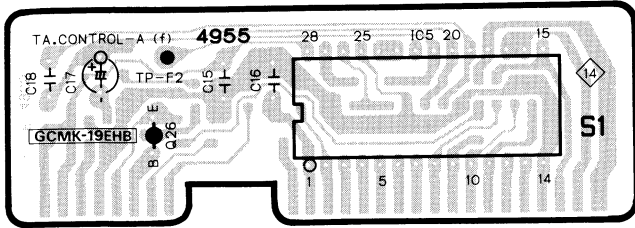

Parts List

Parts No.	Stock No.	Description
• Transistor fQ26	48183400	DTA114YS
• IC fIC5	46321300	BA6150
• Diode fD4 fD5	46852000 46852000	RLS-73 (Chip) RLS-73 (Chip)
fJW1, 2	46741100	Cross Conductor (Chip)
fR17	46750000	10 K Ω 1/8W Chip R.
fR18	46746000	220 Ω 1/8W Chip R.
fR63	46750000	10 K Ω 1/8W Chip R.
fR64	46750600	18 K Ω 1/8W Chip R.

Pattern Side (Chip Parts)

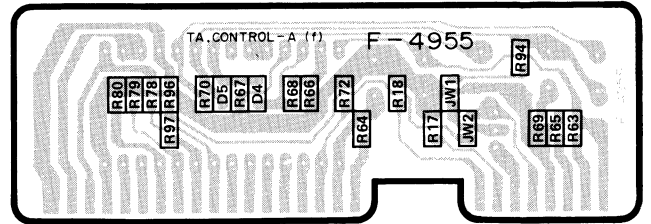

Parts No.	Stock No.	Description
fR65	46745800	180 Ω 1/8W Chip R.
fR66	46751600	47 K Ω 1/8W Chip R.
fR67	46750000	10 K Ω 1/8W Chip R.
fR68	46754000	470 K Ω 1/8W Chip R.
fR69	46751400	39 K Ω 1/8W Chip R.
fR70	46754300	620 K Ω 1/8W Chip R.
fR72	46751600	47 K Ω 1/8W Chip R.
fR78	46753800	390 K Ω 1/8W Chip R.
fR79	46751200	33 K Ω 1/8W Chip R.
fR80	46751200	33 K Ω 1/8W Chip R.
fR94	46750000	10 K Ω 1/8W Chip R.
fR96	46749600	6.8 K Ω 1/8W Chip R.
fR97	46749600	6.8 K Ω 1/8W Chip R.
fC17	46407600	22 μ F 25V E.C.
fC18	46284100	0.1 μ F 50V F.C.

4-9. F-4956 Random Access Control Sub Board

Component Side

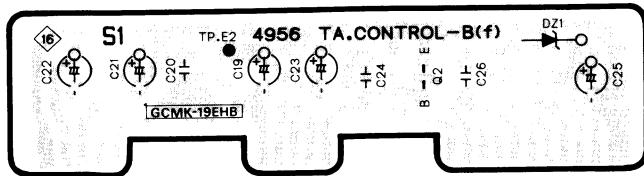

Parts List

Parts No.	Stock No.	Description
• Transistor fQ2	46367101 or 46367301 or 48058801	2SC2603 2SC2458 2SC1740S
• Diode fD7	46852000	RLS-73 (Chip)
• Zener Diode fDZ1	46113300	05Z10-Y
fR71	46754600	820 K Ω 1/8W Chip R.
fR73	46750000	10 K Ω 1/8W Chip R.
fR74	46752000	68 K Ω 1/8W Chip R.
fR75	46751600	47 K Ω 1/8W Chip R.

Pattern Side (Chip Parts)

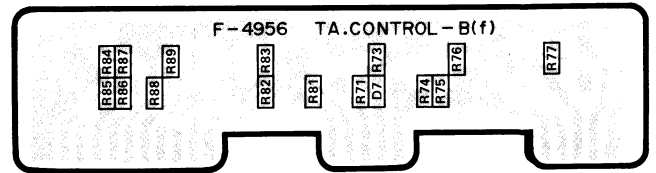

Parts No.	Stock No.	Description
fR76	46753800	390 K Ω 1/8W Chip R.
fR77	46749200	4.7 K Ω 1/8W Chip R.
fR81	46754400	680 K Ω 1/8W Chip R.
fR82	46748500	2.4 K Ω 1/8W Chip R.
fR83	46747600	1 K Ω 1/8W Chip R.
fR84	46746600	390 Ω 1/8W Chip R.
fR85	46746600	390 Ω 1/8W Chip R.
fR86	46746000	220 Ω 1/8W Chip R.
fR87	46746700	430 Ω 1/8W Chip R.
fR88	46752800	150 K Ω 1/8W Chip R.
fR89	46750900	24 K Ω 1/8W Chip R.
fC20	46282400	3300 pF 50V F.C.
fC24	46282600	4700 pF 50V F.C.
fC26	46283300	0.022 μ F 50V F.C.

4-10. F-4958 Indicator Board
Component Side

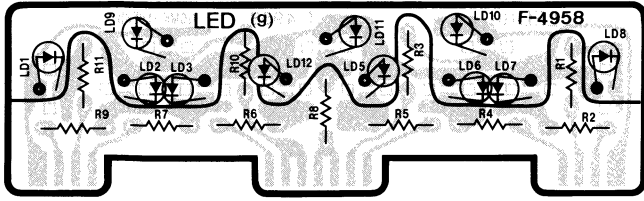

Parts List

Parts No.	Stock No.	Description
• LED		
gLD1	07250900	TLG-123A
gLD2	07250900	TLG-123A
gLD3	07250900	TLG-123A
gLD5	07250900	TLG-123A
gLD6	07250900	TLG-123A
gLD7	07250900	TLG-123A
gLD8	07250900	TLG-123A
gLD9	46095200	TLR-123
gLD10	46095200	TLR-123
gLD11	46095200	TLR-123
gLD12	07250900	TLG-123A

4-11. F-4927 Voltage Selector Board
Component Side

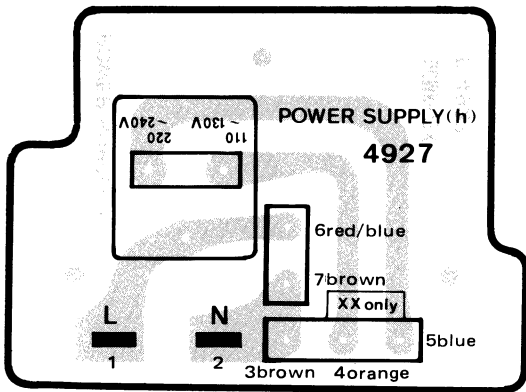

4-12. F-4928 Compu Selector Jack Board
Component Side

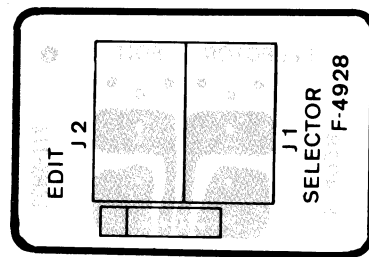

Parts List

Parts No.	Stock No.	Description
fJ1	46547200	Jack, COMPU-SELECTOR
fJ2	46547200	Jack, COMPU-EDIT

5. INTERIOR BLOCK DIAGRAM OF IC

● BA728/NJM2904D (OP Amp.)

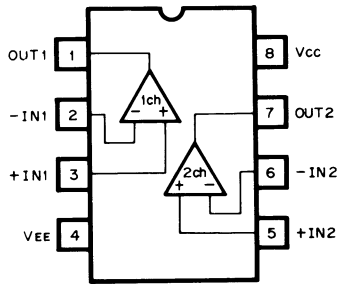

● BA-6150 (Tonearm Servo Control)

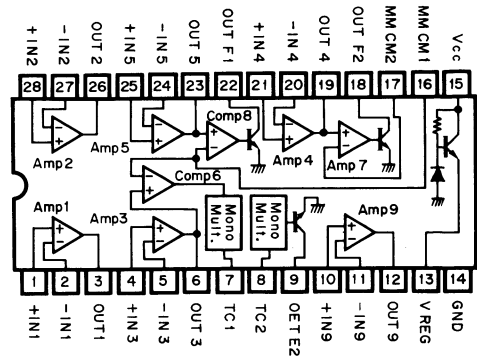

● BA-6250 (7 Transistor Array)

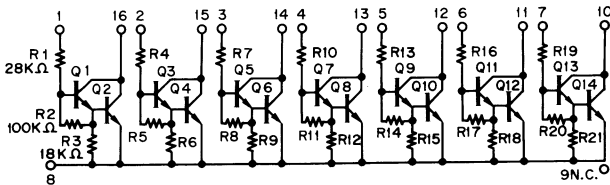

● DT5C114E (5 Transistor Array)

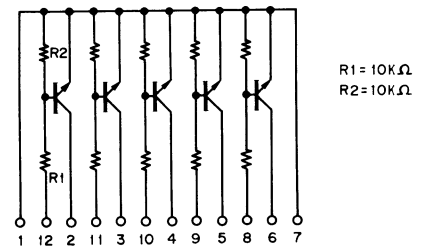

6. OTHER PARTS

6-1. Display Stage

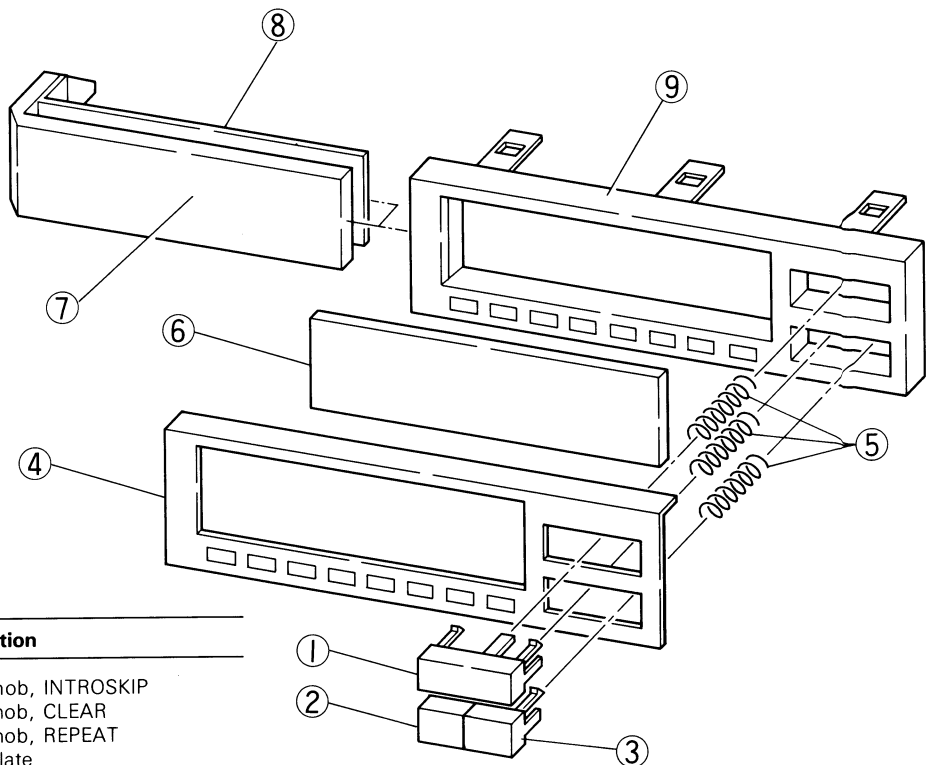

Parts List

Parts No.	Stock No.	Description
1	47767010	Push Knob, INTROSKIP
2	47767110	Push Knob, CLEAR
3	47767210	Push Knob, REPEAT
4	47804100	Dress Plate
5	47816800	Spring, INTROSKIP, CLEAR, REPEAT
6	47782400	Smoked Plate
7	47799500	Display Light Plate
8	47782600	Display Mask Plate
9	47909300	Display Housing Ass'y

6-2. Front View

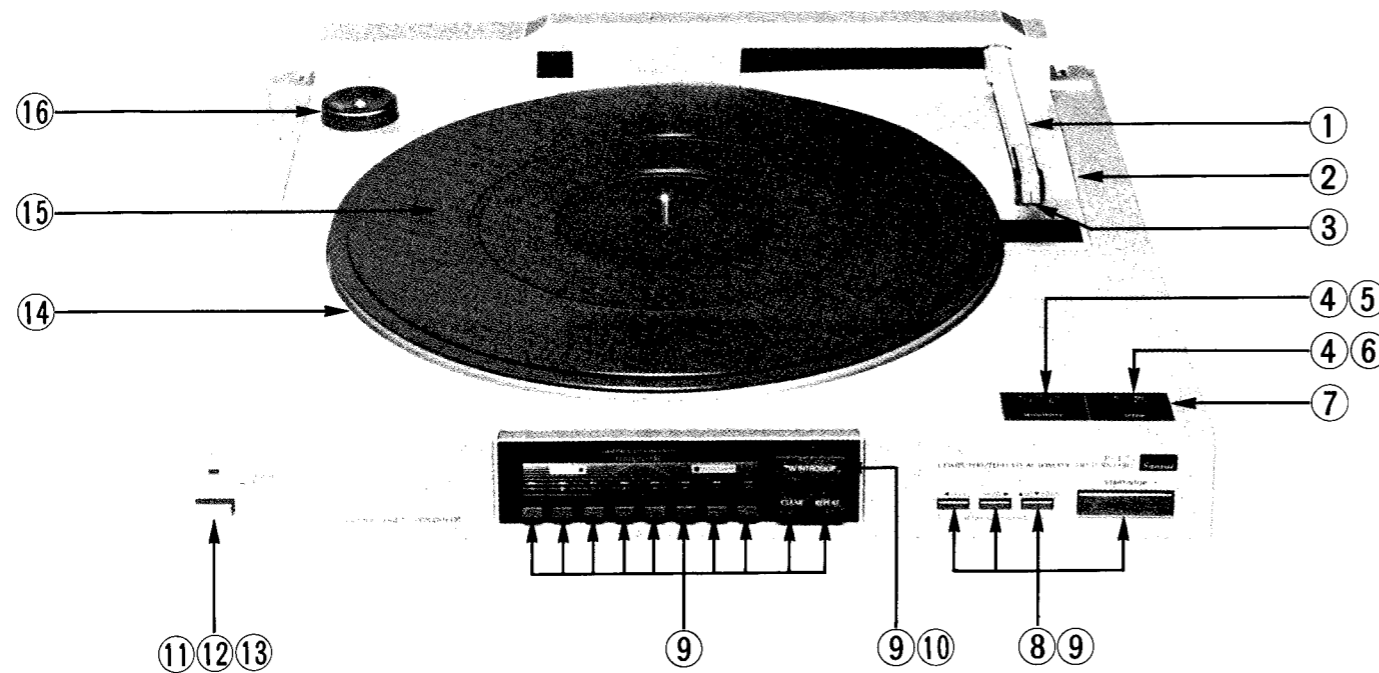

Parts List

Parts No.	Stock No.	Description
1	13732700	Tonearm Ass'y (Silver Model) with Cartridge
	13732800	Tonearm Ass'y (Black Model) with Cartridge
2	47783400	Player Case Cover (Silver Model)
	47783300	Player Case Cover (Black Model)
3	13228400	SN-707 Stylus
4	47766700	Slide Knob, SENSITIVITY, SPEED
5	46133500	Slide SW., SENSITIVITY
6	46133600	Slide SW., SPEED
7	13023910	Switch Plate, SENSITIVITY, SPEED
8	47877600	Push Knob Ass'y (Silver Model), START/STOP, MANUAL CONTROL
	47799300	Push Knob Ass'y (Black Model), START/STOP, MANUAL CONTROL
9	46395900	Push SW., START/STOP, UP/DOWN, RIGHT LEFT, INTROSKIP, REPEAT, CLEAR, RANDOM ACCESS PROGRAM
10	47767400	Push Shaft, INTROSKIP
11	47747000	Push Knob (Silver Model), POWER
	47747100	Push Knob (Black Model), POWER
12	47766600	Push Shaft, POWER
Δ 13	48175900	Push SW., POWER
14	13159710	Platter
15	13099110	Rubber Mat (XX,CSA,EU,BS,AS)
	13099510	Rubber Mat (UL)
16	13012300	EP Adaptor
—	13145100	Insulator

6-3. Top View

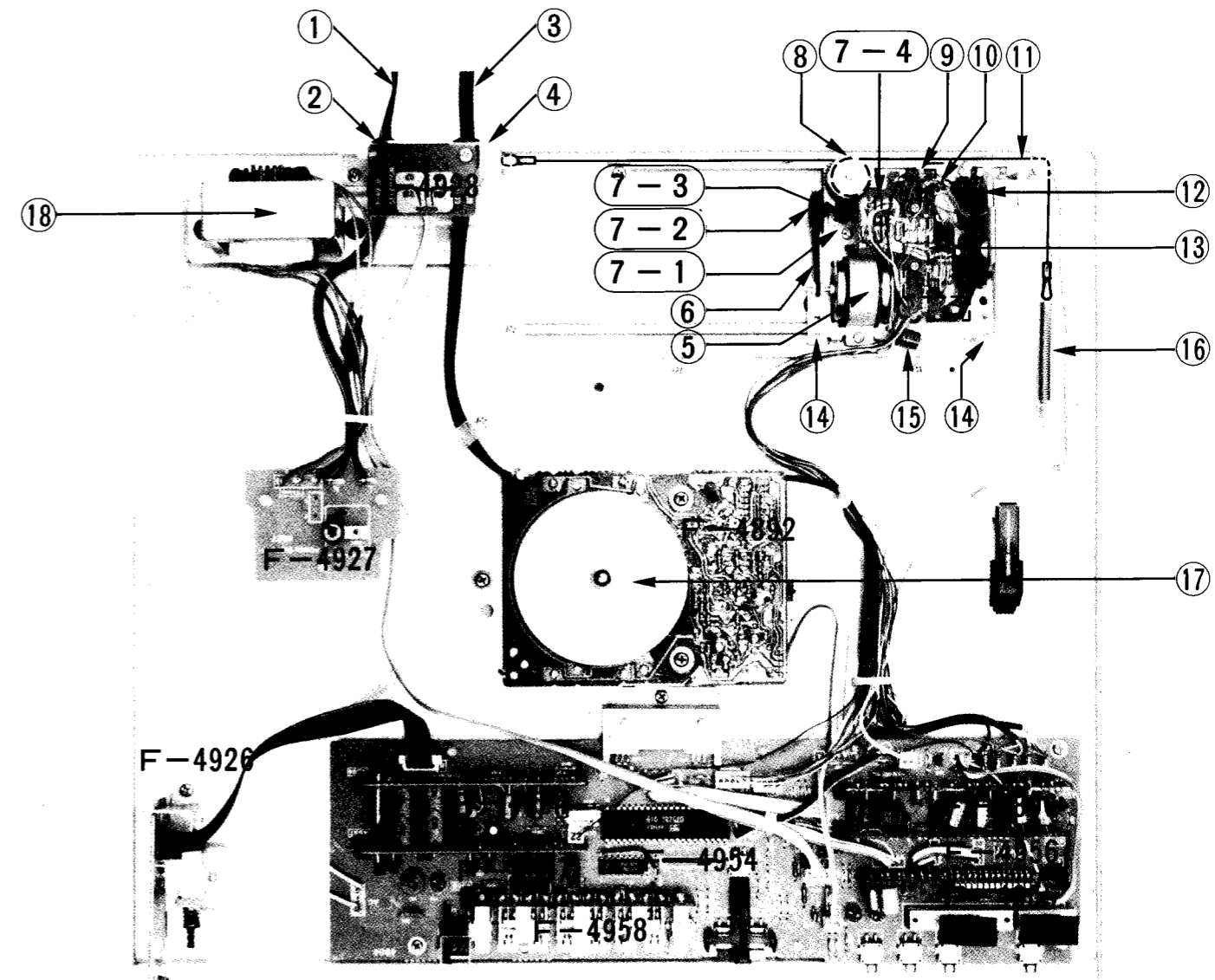

Parts List

Parts No.	Stock No.	Description	Parts No.	Stock No.	Description
Δ 1	46413200	Power Supply Cord (XX)	8	13215810	Drive Gear
Δ 1	38004700	Power Supply Cord (UL)	9	47750200	Bush (B)
Δ 1	48187400	Power Supply Cord (CSA)	10	13280510	Spring, Lead-in Adjust Cam
Δ 1	38004500	Power Supply Cord (EU)	11	47802300	Drive Wire
Δ 1	38004300	Power Supply Cord (BS)	12	46926900	Micro SW., Arm Reset
Δ 1	07204200	Power Supply Cord (AS)	13	48185300	Lifter Solenoid Ass'y
2	39106000	Strain Relief (XX,UL)	14	47750100	Bush (A)
	39104900	Strain Relief (CSA,EU,BS,AS)	15	48097800	22μF 16V E.B.
3	48185600	PU Output Cord (XX,CSA,EU,BS,AS)	16	13220500	Spring, Drive Wire
	48185700	PU Output Cord (UL)	17	18100000	DD Motor Ass'y with F-4892
4	39104900	Strain Relief	Δ 18	15019901	Power Transformer (XX)
5	48170210	Tonearm Control Motor	Δ 1	15019902	Power Transformer (UL,CSA)
6	13103810	Belt	Δ 1	15019905	Power Transformer (EU,BS,AS)
7	13733800	Worm Gear (I) Ass'y			
7-1	—	Bearing, Worm Gear			
7-2	—	Pulley (A)			
7-3	—	Worm Gear			
7-4	—	Slit Plate			

7. SCHEMATIC DIAGRAM

• Design and specifications subject to change without notice for improvement.
 • La présentation et les spécifications sont susceptibles d'être modifiées sans préavis par suites d'améliorations éventuelles.
 • Änderungen, die dem technischen Fortschritt dienen, bleiben vorbehalten.

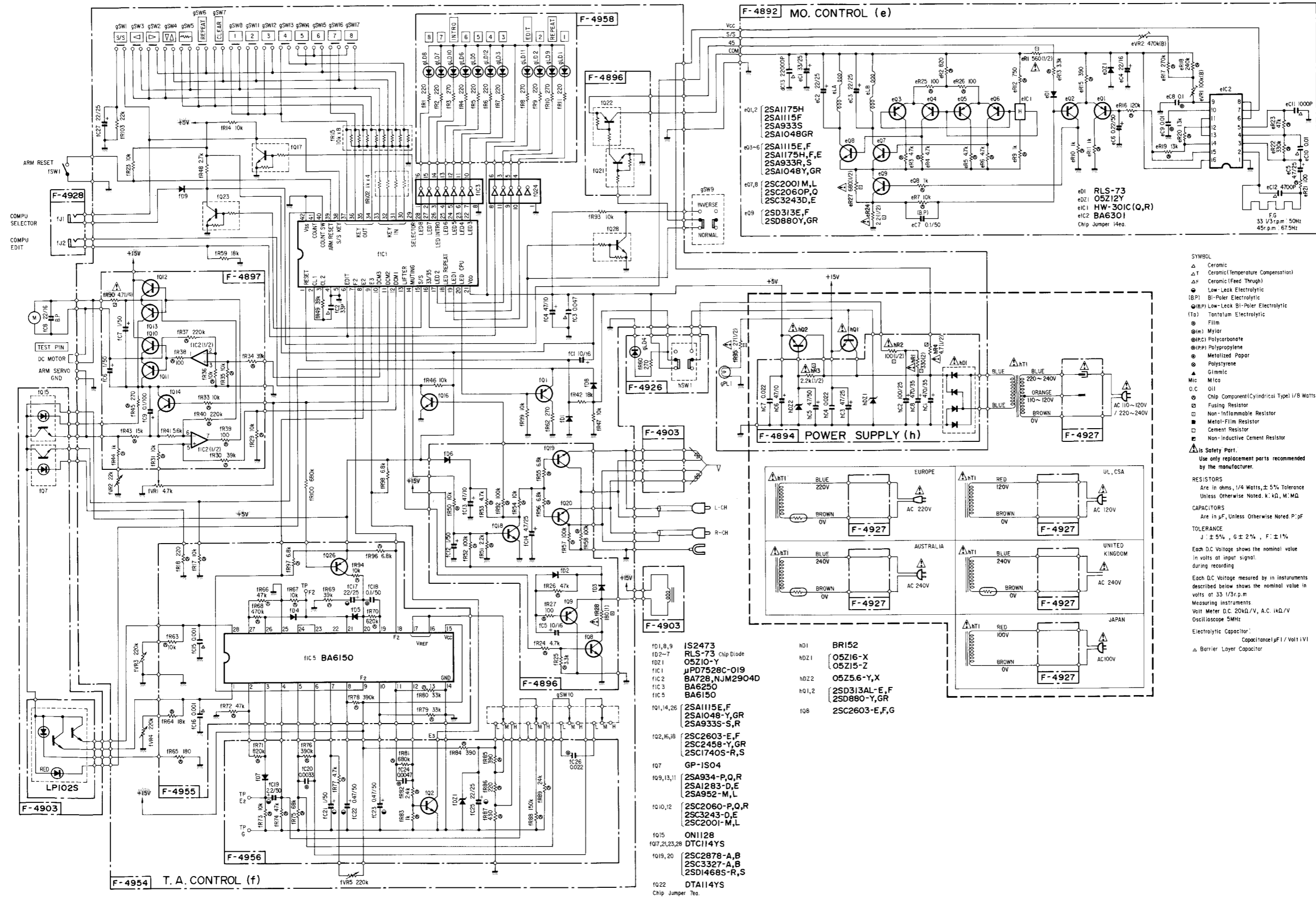

- 2SA1048
- 2SA1115
- 2SC2458
- 2SC2603
- DTC114YS
- DTA114YS
- 2SA934
- 2SA952
- 2SA1283
- 2SA1175
- 2SC2001
- 2SC1740S
- 2SC2060
- 2SC2785
- 2SC2878
- 2SC3327
- 2SC3243
- 2SD1468S

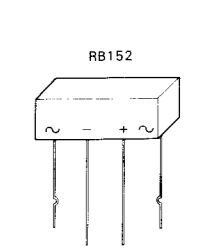
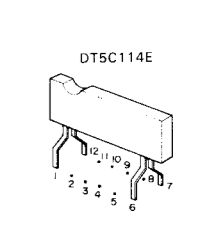
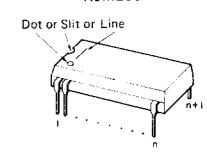
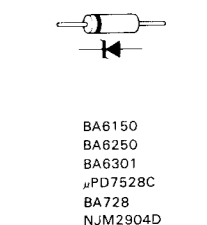
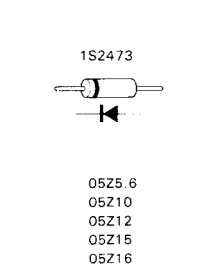
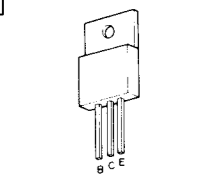
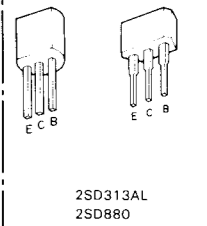

SYMBOL

- △ Ceramic
- △T Ceramic (Temperature Compensation)
- △T Ceramic (Feed Through)
- ⊙ Low-Leak Electrolytic
- (BP) Bi-Polar Electrolytic
- (LBP) Low-Leak Bi-Polar Electrolytic
- (Ta) Tantalum Electrolytic
- Film
- (m) Mylar
- (PC) Polycarbonate
- (PP) Polypropylene
- Metallized Paper
- Polystyrene
- Gimmic
- Mic Micro
- O.C. Oil
- ⊙ Chip Component (Cylindrical Type) 1/8 Watts
- ⊙ Fusing Resistor
- ⊙ Non-Inflammable Resistor
- ⊙ Metal-Film Resistor
- ⊙ Cement Resistor
- ⊙ Non-Inductive Cement Resistor

△ is Safety Part.
 Use only replacement parts recommended by the manufacturer.

RESISTORS
 Are in ohms, 1/4 Watts, ±5% Tolerance
 Unless Otherwise Noted: k: kΩ, M: MΩ

CAPACITORS
 Are in μF, Unless Otherwise Noted: p: pF

TOLERANCE
 J: ±5%, G: ±2%, F: ±1%

Each DC Voltage shows the nominal value in volts at input signal during recording

Each DC Voltage measured by instruments described below shows the nominal value in volts at 33 1/3 r.p.m.

Measuring instruments:
 Volt Meter D.C. 20kΩ/V, A.C. 1kΩ/V
 Oscilloscope 5MHz

Electrolytic Capacitor:
 Capacitance μF / Volt V1
 △ Barrier Layer Capacitor

- 101,8,9 IS2473
- 102-7 RLS-73 Chip Diode
- 1021 O5Z10-Y
- 1022 O5Z15-Z
- 1023 JPD7528C-019
- 1024 BA728, NJM2904D
- 1025 BA6250
- 1026 BA6150
- 101,14,26 2SA1115E,F
- 2SA1048-Y,GR
- 2SA933S-S,R
- 102,16,18 2SC2603-E,F
- 2SC2458-Y,GR
- 2SC1740S-R,S
- 107 GP-1S04
- 109,13,11 2SA934-P,Q,R
- 2SA1283-D,E
- 2SA952-M,L
- 1010,12 2SC2060-P,Q,R
- 2SC3243-D,E
- 2SC2001-M,L
- 1015 ON1128
- 1017,21,23,28 DTC114YS
- 1019,20 2SC2878-A,B
- 2SC3327-A,B
- 2SD1468S-R,S
- 1022 DTA114YS
- Chip Jumper 7ea.
- 101 BR152
- 1021 O5Z16-X
- O5Z15-Z
- 1022 O5Z16-Y,X
- 101,2 2SD313AL-E,F
- 2SD880-Y,GR
- 108 2SC2603-E,F,G

8. PACKING LIST

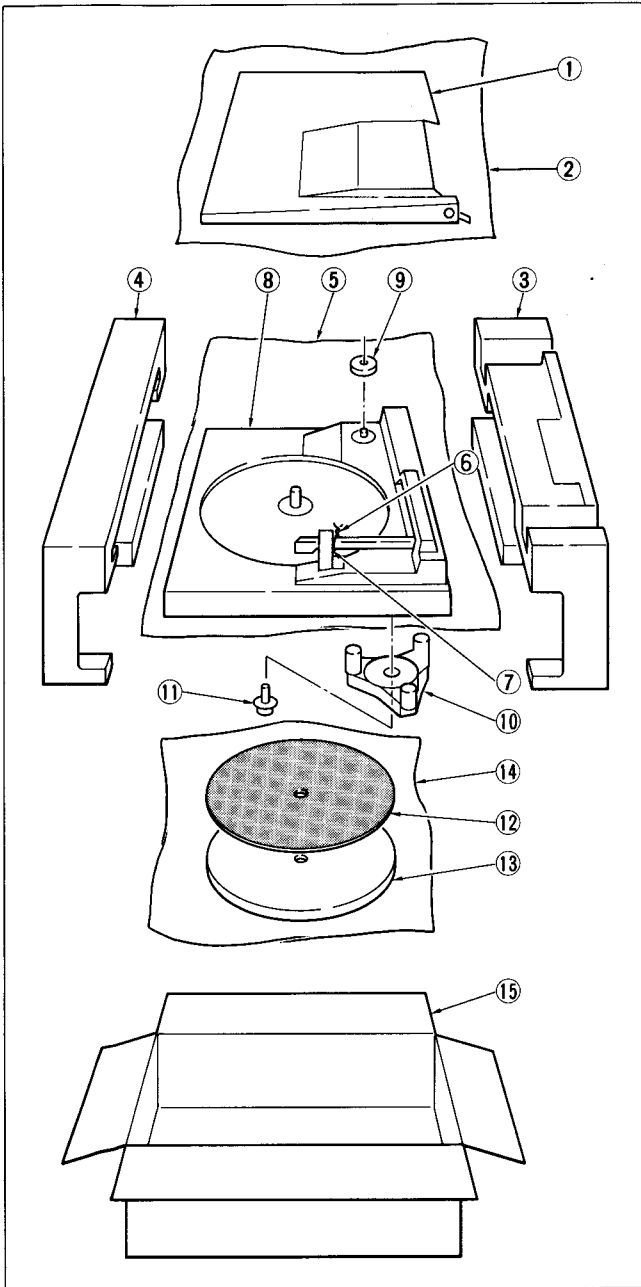

Parts List

Parts No.	Stock No.	Description
1	47877800	Dust Cover Ass'y
1-1	48179600	Hinge Cap (Silver Model)
	13187400	Hinge Cap (Black Model)
1-2	48179700	Hinge (L)
1-3	48179800	Hinge (R)
2		Vinyl Bag, Dust Cover
3	47817100	Styrofoam Packing (Rear)
4	47816900	Styrofoam Packing (Front)
5	91122710	Vinyl Bag, Unit
6		Binder
7		Tonearm Packing
8		Unit
9	13012300	EP Adaptor
10	47800100	Protector
11	00449700	M4 x 12 Pan Head SEMS Screw
12	13099110	Rubber Mat (XX,CSA,EU,BS,AS)
	13099510	Rubber Mat (UL)
13	13159710	Platter
14		Vinyl Bag, Rubber Mat & Platter
15	47808600	Carton Case (Silver Model with Dust Cover)
	47808800	Carton Case (Black Model with Dust Cover)
	47809100	Carton Case (Silver Model without Dust Cover)
	47809000	Carton Case (Black Model without Dust Cover)

9. ACCESSORY LIST

Stock No.	Description
46968500	Operating Instruction
46974100	Caution Sheet
48181600	Mini Pin Cord, Compu Selector